



 **DURATO**[®]

PRODUCT COLLECTION.

LOOKBOOK ————— duratousa.com



MADRID

CELEBRATING
A DECADE



FLOORING
YOUR WORLD

DURATO®

BREATHE EASY

Our products are manufactured to LEED and FloorScore standards for Indoor Air Quality and are certified to be free of Volatile Organic Compounds. Volatile Organic Compounds (VOCs) are chemicals found in many products

used to build and maintain homes that are released into the indoor air we breathe; with Durato flooring in your space, you can breathe easy knowing VOCs are no concern.

QUANTUM X™ TECHNOLOGY

Diamond Enhanced Wear Layer Resistant to Scratches, Stains, and Dents.

A coveted symbol of beauty and longevity, diamonds are one of nature's hardest surfaces. With their unrivaled strength, real diamonds are the key ingredient in our Quantum X™ Technology Wear Layer,

which results in unparalleled protection for our floors. The double UV Fade coating ensures the product is flame/stain/scratch/indent resistant so your floor stays looking as good as it did when it was installed.



Look for the "Protected by Quantum X™ Technology" wear layer Badge to signify the very best in flooring protection.

PROTECTED BY QUANTUM X TECHNOLOGY

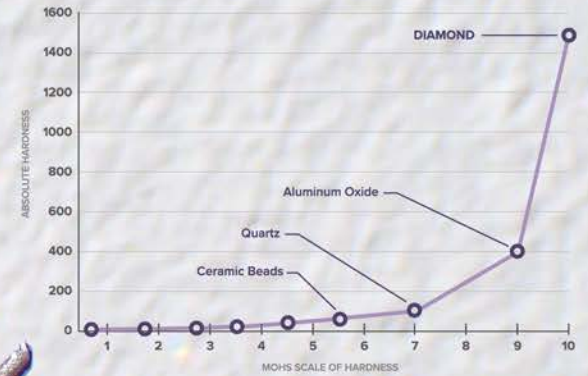

MEASURING SCRATCH RESISTANCE

The Mohs scale of mineral hardness rates the scratch resistance of various minerals. While many flooring products utilize materials such as Aluminum Oxide, Quartz, and Ceramic Beads for durability, Diamonds dwarf those elements on the Mohs scale.



















AuthenTex™ Finish

Our AuthenTex™ Finish combines high definition imagery with an Embossed in Register (EIR) to expertly recreate the look and feel of natural hardwood. Unlike many flooring products that are manufactured with random or no embossing, AuthenTex perfectly traces the wood grain to create indentation where needed and provides a stunningly realistic finish. Unlike smooth floors that lack embossing, the AuthenTex finish also provides a level of slip resistance for added safety, as the textured surface is easier to traverse. By combining the timeless look of classic high-end hardwood with the benefits of modern flooring, the result is a surface that feels as luxurious as it looks.



WHICH PRODUCT LINE IS RIGHT FOR YOU?

V-EVO^{XL}	V-EVO^{MAX}	azul⁺ tortuga	panzu⁺ BY DURATO
20mil wear layer	20mil wear layer	20mil wear layer	12mil wear layer
 Extra Large Planks 8.97" x 70.68"	7" x 48"	7.2" x 48"	7" x 48"
7.0mm overall thickness	7.0mm overall thickness	5.0mm overall thickness	4.7mm overall thickness
 Waterproof	 Waterproof	 Waterproof	 Waterproof
 Quantum X™ Technology	 Quantum X™ Technology	 Quantum X™ Technology	 Quantum X™ Technology
 Suitable for Heavy Commercial Use	 Suitable for Heavy Commercial Use	Light Commercial Use	Light Commercial Use
 ClimateGuard™ Technology	 ClimateGuard™ Technology	 ClimateGuard™ Technology	—
 AuthenTex™ Finish	 AuthenTex™ Finish	—	—
—	—	—	—

CLICK LOCKING SYSTEM

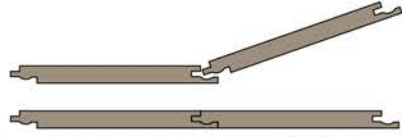

We listened to the commercial flooring mechanics and developed a modified locking system invented by two patent holders. We improved it by partnering with the tool makers and asked if we could experiment with different angles and thickness to see if it would improve installer experiences. After numerous attempts we were able to find a unique cutting tool profile that works better. All Durato Floors are made to a higher standard. We believe better ingredients, ingenuity, processes and after sales support is the key to successful flooring installations.

FEATURES

- Modified click lock based on the strongest and easiest locking systems
- Unique angle of locking mechanism
- Thicker and longer locking system for ease of install and stronger lock
- Quicker install time

IXPE PAD

FEATURES

- 100% waterproof
- Impervious to mildew, mold, rot, and bacteria
- Excellent insulator, perfect for radiant heat floors
- Superior sound reduction

Our IXPE is the newest advanced cross-linked foam technology designed to provide supreme sound reduction, shock absorption and advanced moisture protection. All Durato floors come with the IXPE pad already adhered to the back of each plank for easy installation as well as providing a healthier, softer, and quieter living space.



*Quality
that will
FLOOR you...*

DURATO PROUD.

Making a better product starts at the foundation with the best ingredients. Durato sources the highest grade virgin raw materials for its Stone Polymer Composite core, utilizing less plastic and focusing on a mineral-based composition. Our process includes the finest global technology available to the industry: UV stable paints from Germany, titanium pressing plates designed in Italy, and a hardening process found in Belgium.

Our commitment to innovation has led to industry-wide advancements, such as our Quantum X™ Wear Layer, which provides applicable products with industry-leading protection against scratches, stains, and dents.

The ClimateGuard™ core of our V-EVO® series withstands extreme heat and extreme cold, resulting in the best-performing Stone Polymer Composite flooring in non-temperature controlled environments, such as those found in new multi-family construction sites.

We take great pride and are committed to developing **the best flooring options for the best value on the market** over the last decade.

COLLECTIONS |



BERLIN PANZU-01



TULUM PANZU-07



CANCUN PANZU-02



SYDNEY PANZU-08



COPA PANZU-03



SICILY PANZU-14



AMSTERDAM PANZU-04



KYOTO PANZU-15

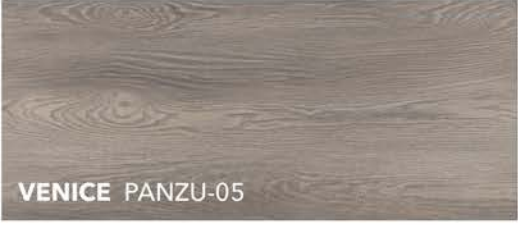

VENICE PANZU-05



OSLO PANZU-16



DUBLIN PANZU-06



MADRID PANZU-17



COPA

 **QUANTUM X™ TECHNOLOGY**
Industry-leading resistance to scratches,
stains and dents, strengthened by
real titanium.

 **LIFETIME**
LIMITED RESIDENTIAL
WEAR WARRANTY

 **10 YEAR**
LIMITED LIGHT COMMERCIAL
WEAR WARRANTY



AMSTERDAM



TULUM



azul  tortuga
by DURATO®

BLUE SANDS

MILE HIGH AT-02	MYRTLE BEACH AT-17
VENICE BEACH AT-03	ISLAMORADA AT-18
REHOBOTH AT-04	AMELIA AT-19
ANTIGUA AT-05	WHITEHAVEN AT-20
WILDWOOD CREST AT-07	BLUE SANDS AT-21
OAKWOOD AT-12	LOREDO AT-22
CANNES AT-13	SANTORINI AT-24
BISCAYNE AT-14	MANCORA AT-25
GALWAY AT-15	PALOMINO AT-26
BRIGHTON AT-16	CAPTIVA AT-27

 **QUANTUM X™ TECHNOLOGY**
Industry-leading resistance to scratches,
stains and dents, strengthened by
real titanium.

 **LIFETIME**
LIMITED RESIDENTIAL
WEAR WARRANTY

 **10 YEAR**
LIMITED LIGHT COMMERCIAL
WEAR WARRANTY



CANNES

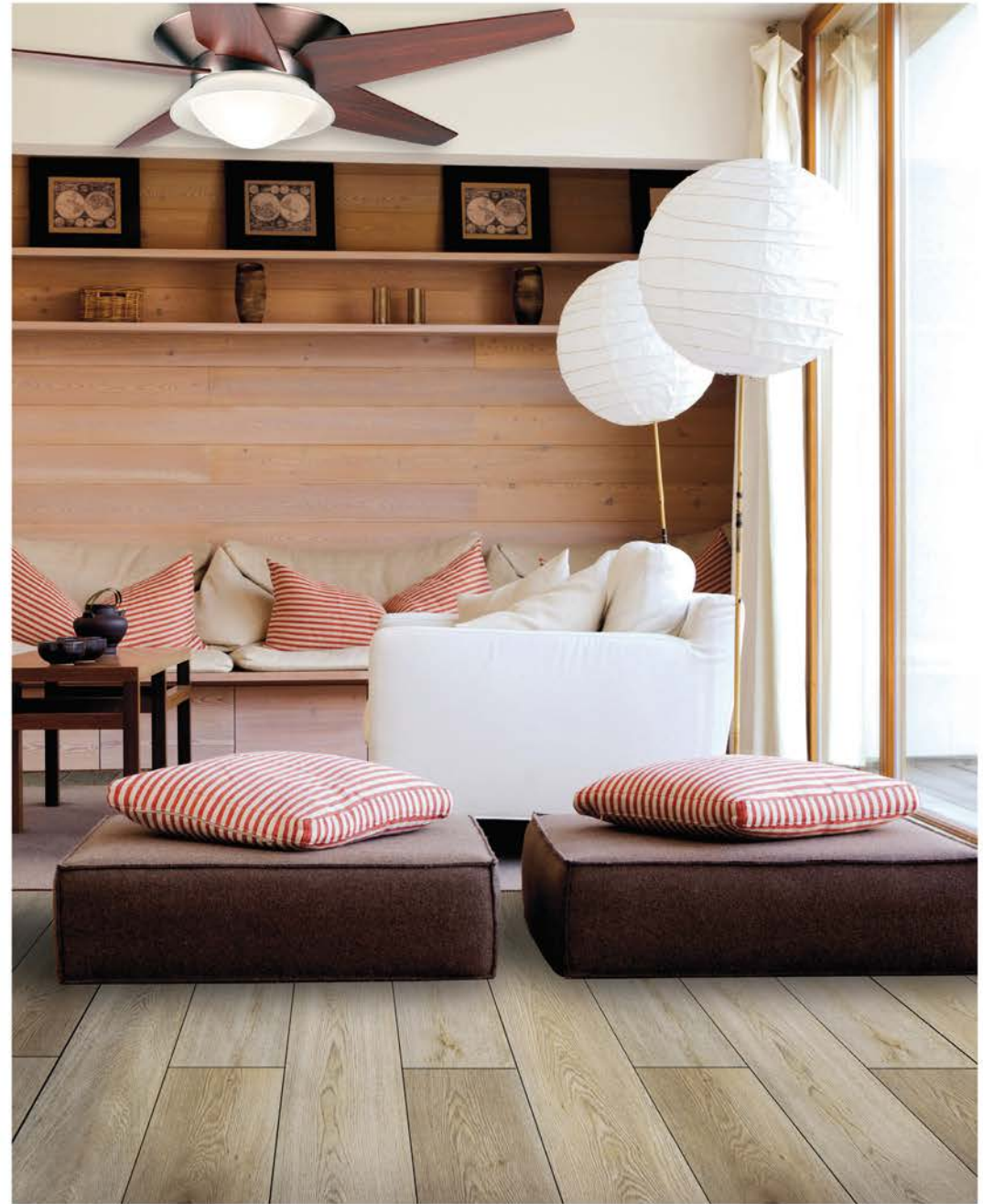

REHOBOTH



V-EVO[®] MAX

By Dürato[®]



FLORENCE VMD-01



DRESDEN VMD-07



WOOLWORTH VMD-02

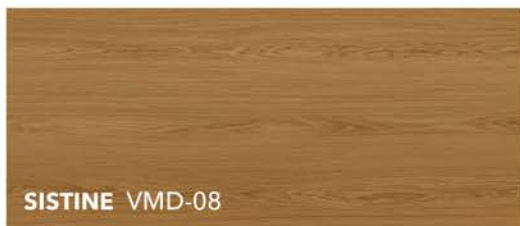

SISTINE VMD-08



BAYMONT VMD-03



GHERKIN VMD-09



WENTWORTH VMD-04



SAVOYE VMD-10



BLENHEIM VMD-05



PETRONAS VMD-11



BUCKINGHAM VMD-06



CAYAN VMD-12

WENTWORTH

 <p>QUANTUM X™ TECHNOLOGY Industry-leading resistance to scratches, stains and dents, strengthened by real titanium.</p>	 <p>HEAVY COMMERCIAL USE Durable enough to withstand heavy, everyday, foot traffic.</p>	 <p>AUTHENTEX™ FINISH High-definition imagery plus an Embossed in Register creates an authentic wood look and texture.</p>	 <p>CLIMATEGUARD™ RESISTANCE Resists extreme temperatures, allowing product to be used in 3-season spaces.</p>	
 <p>LIFETIME LIMITED RESIDENTIAL WEAR WARRANTY</p>	 <p>LIFETIME LIMITED STRUCTURAL WARRANTY</p>	 <p>LIFETIME LIMITED WATERPROOF WARRANTY</p>	 <p>10 YEAR LIMITED COMMERCIAL WEAR WARRANTY</p>	 <p>5 YEAR LTD ENCLOSED PATIO & CABIN WARRANTY</p>



FLORENCE



WOOLWORTH



V-EVO[®] XL
By Dürato



BISCOTTI XL-01



PORCINI XL-06



OAT XL-02



TRUFFLE XL-07



SEA SALT XL-03



BONBON XL-08



OYSTER XL-04



CARAMEL XL-09



MAPLE XL-05



MOCHA XL-10

BONBON

 <p>LARGE AND LUXURIOUS Ultra-long and extra-wide planks provide an upscale look, and are 89% larger than standard 7"x48" planks.</p>	 <p>QUANTUM X™ TECHNOLOGY Industry-leading resistance to scratches, stains and dents, strengthened by real titanium.</p>	 <p>HEAVY COMMERCIAL USE Durable enough to withstand heavy, everyday, foot traffic.</p>	 <p>AUTHENTEX™ FINISH High-definition imagery plus an embossed in Register creates an authentic wood look and texture.</p>	 <p>CLIMATEGUARD™ RESISTANCE Resists extreme temperatures, allowing product to be used in 3-season spaces.</p>
 <p>LIFETIME LIMITED RESIDENTIAL WEAR WARRANTY</p>	 <p>LIFETIME LIMITED STRUCTURAL WARRANTY</p>	 <p>LIFETIME LIMITED WATERPROOF WARRANTY</p>	 <p>10 YEAR LIMITED COMMERCIAL WEAR WARRANTY</p>	 <p>5 YEAR LTD ENCLOSED PATIO & CABIN WARRANTY</p>



BISCOTTI



TRUFFLE

*“The Best Value,
Tailored to Your Needs”*

We specialize in tailoring bespoke designs and possess the expertise to engineer flooring according to your specific requirements. Whether it's custom pattern, color, thickness, wearlayer, size, shape, and more, we can accommodate your needs. Minimum order quantities are applicable. **Reach out to your local representative or collaborate with our in-house design team for further assistance.**

**CUSTOM DESIGN &
VALUE ENGINEERING |**

BRIGHTON

PALOMINO

LOREDO

OAKWOOD



*“Quality is defined
by attention to detail.”*

Durato USA offers running line accessories to enable efficient installation of the full product line. Custom options are available upon request and minimums do apply. Collaborate with your local representative or our team of in-house designers.

*“Excellence isn’t about
meeting the spec, it’s
about setting the spec.”*

Durato USA creates flooring specifications that exceed the current industry standards. Our products focus on quality engineering to achieve a vast array of offerings for both the residential and commercial sectors. Our team of technicians can review your project requirements and help guide your design.

**ACCESSORIES |
& SPECS |**

ACCESSORIES and MOLDING

3-in-1 TRIM MOLDING

Our 3-in-1 trim molding is the perfect way to create a seamless transition for your Durato floor with its ability to function as a reducer, t-molding, or an end cap.

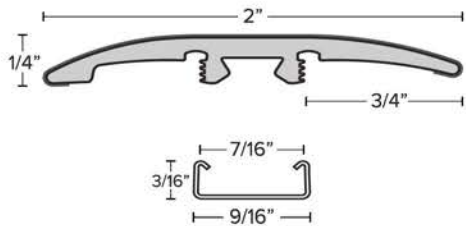

FLUSH STAIR NOSE

Our flush stair nose helps create a perfect transition from your Durato floor to your stairs, for a seamless finish.

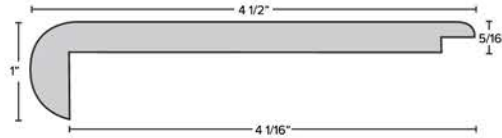

*Combined with Durato Stone Polymer Composite flooring to cover stair treads (94.5" long).

STAIR TREAD

Introducing a durable, waterproof vinyl stair tread. A seamless, one-piece solution for a quick and perfect finish every time.



DIMENSIONS

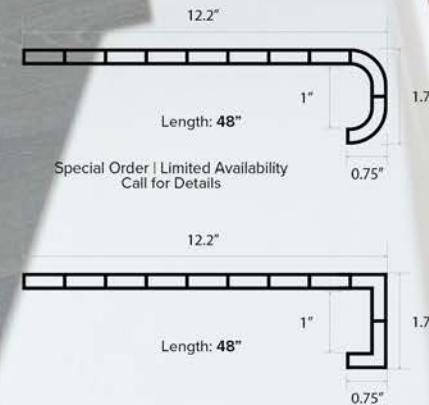

FEATURES

- 100% Waterproof
- Kid and pet friendly, easy to clean and maintain
- Scratch resistant
- Seamless one piece stair tread for quick, clean and consistent installation
- Pre-attached nosing for easy front install
- Included end cap that can be customized for a left, right, open, or wide stair

*Currently only available in Vevo XL series



1 REDUCER



Track

2 T-MOLDING 3 END CAP



Track Shim



Carpet Tap Down Trim



MAKING THE GRADE

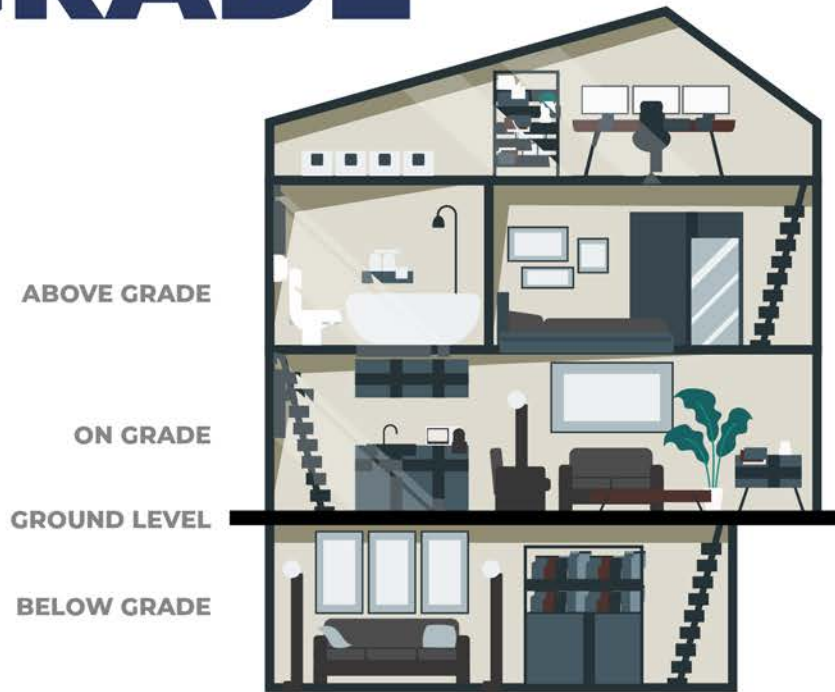

What Are Grade Levels?

Grade level relates to the floor/story of a home. A basement would be below grade, the first floor would be on grade, and the second story and above would be above grade.

Why Do The Grade Levels Matter?

While Above Grade installations never require a vapor barrier, many flooring products require a vapor barrier if installed On or Below Grade due to potential damage from moisture.

Do Durato floors require a vapor barrier for On or Below Grade installations?

All Durato flooring is waterproof and will not react to moisture, so in most cases a vapor

barrier is unnecessary. However, while our flooring will not react to moisture, it does not act as a waterproof barrier. When installing On or Below Grade in areas with hydrostatic pressure or moisture coming from walls or subfloors, a vapor block should be used. In addition, when installed over subfloors with high alkalinity, an alkaline deposit may form. While this can be washed away, we recommend using a moisture barrier in such cases to reduce maintenance following major rain storms. When installing Durato flooring in a bathroom, we recommend a vapor barrier and to silicone the perimeter to prevent moisture from showers and tubs from reaching the subfloor.

The ClimateGuard™ Technology on Durato flooring was developed to ensure protection against extreme temperatures ranging from -17° F to 176° F.



Unlike other flooring products that suggest temperature ranges between 55° F to 100° F, Durato flooring is ideal for environments that experience any seasonal temperature fluctuations, such as new construction projects, log cabins, and covered patios; with the ability

to withstand frigid temperatures as low as -17° F up to scorching highs of 176° F, Durato flooring will guard against extreme temperature fluctuation in any sensitive environment.

**All Durato Stone Polymer Composite products are 100% Waterproof and, in most circumstances, does not require a vapor barrier to protect against moisture from On or Below Grade installations. We do recommend to seal the concrete if extremely low or extremely high alkalinity.*

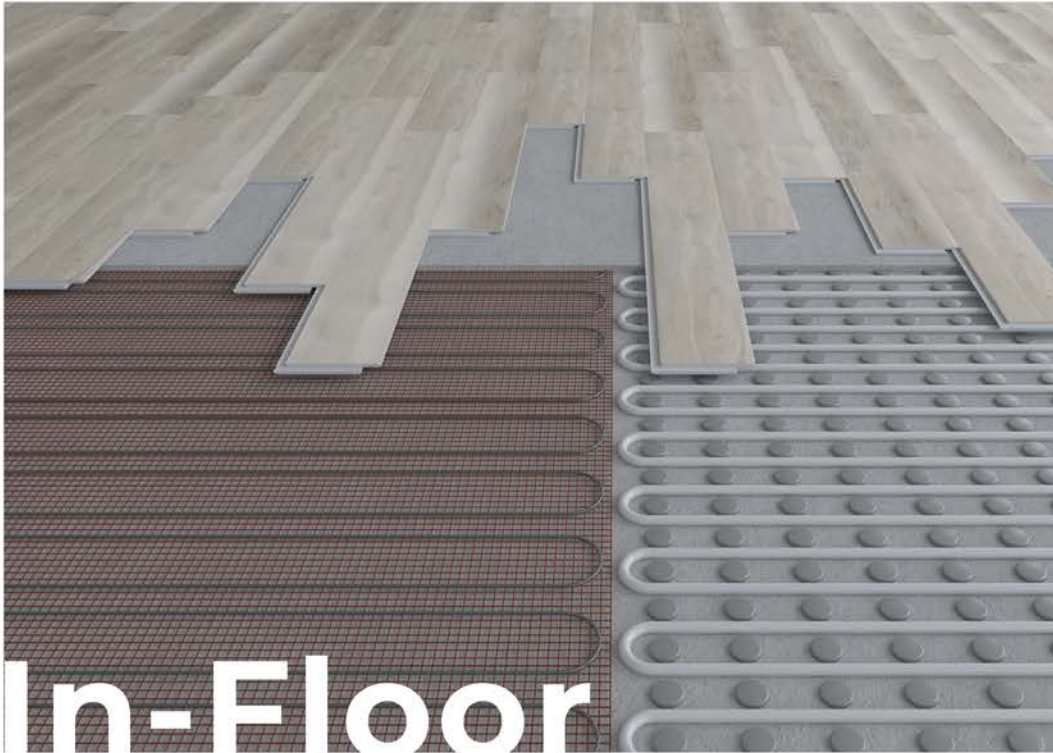

In-Floor Radiant Heat

Guidelines for Heating Mats and Hydro.

All Durato flooring products were designed to be able to install over in-floor radiant heating.

If radiant heating flooring manufacturer recommends adhesive, use only recommended adhesive over manufacturer's recommended plywood substrate.

- Turn the heat off for 24 hours before, during and 24 hours after installation when installing over radiant heated subfloors.
- Failure to turn the heat off may result in shortened working time of the adhesive.
- Floor temperature must not exceed 85° F (30° C).
- Failure to strictly follow adhesive manufacturer's guidelines may result in failure and void warranty.

**It is recommended that changes in temperature be gradual.*

Our CLIENTS

Designed specifically for multi-family developments and single family homes, Durato has been trusted by some of the biggest builders in the industry. With unparalleled quality control, industry-leading durability, responsive customer service, and competitive pricing, Durato Stone Polymer Composite floors are a perfect choice for any residential or commercial project.



DURATO . / # 2

TRUSTED BY



PRODUCT SPECIFICATIONS

	WIDTH	LENGTH	THICKNESS	WEAR LAYER	PLANKS / CARTON	SQ FT / CARTON	CARTONS / PALLET	SQ FT / PALLET
V-EVO[®] XL <small>by DURATO</small>	8.97"	70.86"	7.0mm	20mil with QXT	4	17.67	52	918.84
V-EVO[®] MAX <small>by DURATO</small>	7"	48"	7.0mm	20mil with QXT	6	14.1825	60	850.95
azul[®] tortuga <small>by DURATO</small>	7.2"	48"	5.0mm	20mil with QXT	10	24.028	55	1,321.54
panzu <small>by DURATO</small>	7"	48"	4.7mm	12mil with QXT	12	28.365	50	1,418.25

MOLDINGS AVAILABLE



3-in-1 (Reducer/T-Molding/Endcap)



Flush Stair Nose



Stair Tread

*Only Available in V-EVO XL Series



EM
1931
TANLEY
MORISON
W
RN

"THEN YOU WILL WALK
ON YOUR WAY SECRETLY, AND YOUR
FOOT WILL NOT SLUMBER."
PROVERBS 3:23

"Angels"
appear
if you
stop
worry."
- J.K. Rowling

THE AMERICANS
OFFICE: MOMENTS BY HANSEN 1784-1992
70s Style & Design
Elliott Frantz Space

INNENARCHITECTUR



DURATO®



HEADQUARTERS

600 Edwards Road
Fort Pierce, FL 34982
ph: 267.343.3480

DURATO PHILLY

9800 Bustleton Ave
Philadelphia, PA 19115

DURATO HOUSTON

8451 Market Street, Suite 150
Houston, TX 77029

LOOKBOOK ————— duratousa.com

PUBLISHED : JANUARY 2025